



**MH46000DF 1OHM  
owner's manual**

————— MANUAL —————

# Specifications

## Amplifier section

Power output MAX(watts)	6000W
THD	≤0.1%
frequency response ( ± 1dB )	20Hz~20KHz
signal to noise ratio	>85dB
sensitivity	0.2~6V
recommended fuse type	40 A X 4
dimensions	352mm X 239mm X 54mm

## System planning

Proper system planning is the best way to maximize your amplifier performance. By planning your installation carefully you can avoid situations where the performance of the reliability of your system is compromised. Your authorized dealer has been trained to maximize your system's sonic potential. Your dealer is a valuable resource in helping you with your system design and installation.

### Speaker requirements

Each channel of your amplifier can easily drive 4Ω speaker loads when used in the stereo mode. When a channel-pair is bridged, the recommended minimum load impedance is 3Ω for subwoofer use, and 4Ω for full range operation. Although operation with lower impedances is not likely to cause immediate damage to the internal circuitry, the unit will most likely overheat, causing the thermal protection circuitry to shut down the amplifier. When the chassis cools down, normal operation will resume. Continuing to operate the amplifier under these conditions is not recommended and will reduce its life expectancy.

Most speakers designed for car audio operation are 4Ω impedance. Connecting two such speakers in parallel will result in a 2Ω impedance load as seen by the amplifier. Some subwoofer models feature a dual 4Ω voice coil design. Connecting these voice coils in parallel will result in a 2Ω nominal impedance, which is not recommended for use with bridged channels of your amplifier.

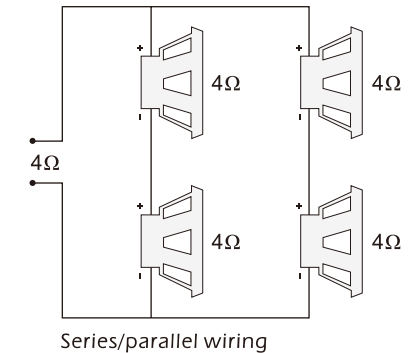
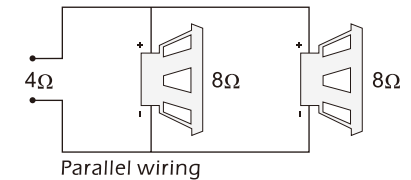
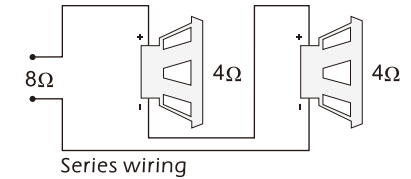

# Power Connection Leads

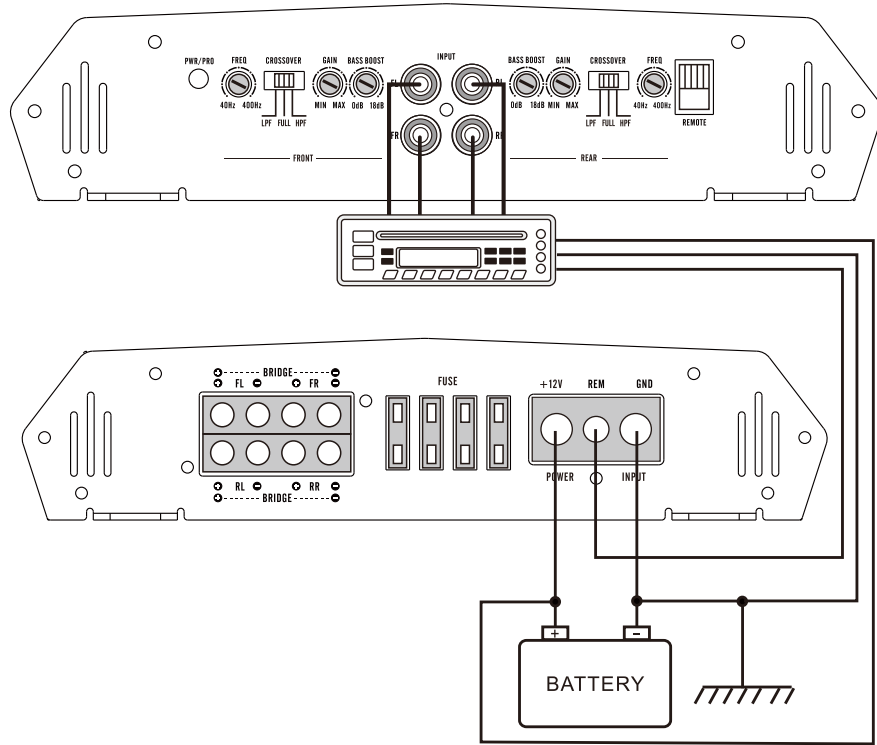

## Notes on the power supply

Connect the +12V power input lead only after all other leads have been connected.

Be sure to connect the ground wire of the unit securely to a metal part of the car.

A loose connection may cause a malfunction of the amplifier.

REMOTE: The unit is turned on by applying +12Volts to this terminal. This terminal does not draw heavy current like the two power terminals so a thinner connecting wire is acceptable. Standard 18 GAUGE is fine and the standard colour is yellow. If the radio is equipped with a power antenna control wire, it can drive this terminal. If the power antenna wire is already in use, you can still splice into it. With this method, the unit will turn on automatically with the radio. Use the power supply lead with a fuse attached whose value is the same as original fuse.

Place the fuse in the power supply lead as close as possible to the car battery.

During a full power operation, Maximum current will run through the system. Therefore, Make sure that the leads to be connected to the +12v and GND terminals of the unit respectively must be larger than 10-Gauge (AWG.10).

## Symptom

## possible cause

## action to take

	internal crossover not set properly for speaker	reset crossovers referring to the multi-cross crossover configuration section of this manual
distorted output (cont'd)	speakers are blown	check system with known working speakers and repair or replace as needed
poor bass response	speakers wired wrong polarity causing cancellation at low frequencies	check speaker polarity and repair as needed
	crossover set incorrectly	reset crossovers referring to the multi-cross crossover configuration section of this manual for detailed instructions
battery fuse blowing	impedance load to amplifier too low	check speaker impedance load, if below 2Ω stereo or 4Ω mono rewire speakers to achieve a higher impedance
	short in power wire or incorrect power connections	check power and ground connections and repair as needed
	fuse used is smaller than recommended	replace with proper fuse size
	too much current being drawn	check speaker impedance load, if below 2Ω stereo or 4Ω mono rewire speakers to achieve a higher impedance
	short in power wire or incorrect	check power and ground connections and repair as needed
amplifier fuse blowing	too much current being drawn	check speaker impedance load, if below 2Ω stereo or 4Ω mono rewire speakers to achieve a higher impedance and replace with recommended fuse size
	fuse used is smaller than recommended	check power and ground connections and repair as needed replace with proper fuse size

# Troubleshooting

symptom	possible cause	action to take
no output	low or no remote turn-on input	check remote turn-on voltage output at amplifier and correct as needed
	fuse blown	check power wire integrity and reversed polarity, repair as needed and replace fuse
	power wires not connected	check power wire and ground connections and repair or replace as needed
	audio input not connected or no output from source	check input connections and signal integrity, repair or replace as needed
	speaker wires not connected	check speaker wires and repair or replace as needed
audio cycles on and off	speakers are blown	check system with known working speaker and repair or replace speakers as needed
	thermal protection engages when amplifier heatsink temperature exceeds 90°C	make sure there is proper ventilation for amplifier and improve ventilation as needed
	loose or poor audio input	check input connections and repair or replace as needed
distorted output	amplifier level sensitivity set too high; exceeding maximum output capability of amplifier	reset gain referring to the tuning section of the manual for detailed instructions
	impedance load to amplifier too low	check speaker impedance load if below 2Ω stereo or 4Ω mono rewire speakers to achieve a higher impedance
	shorted speaker wires	check speaker wire connections and repair or replace as needed
	speaker not connected to amplifier properly	check speaker wiring and repair or replace as needed refer to the installation section of this manual for detailed instructions

system 1: 4 channel mode

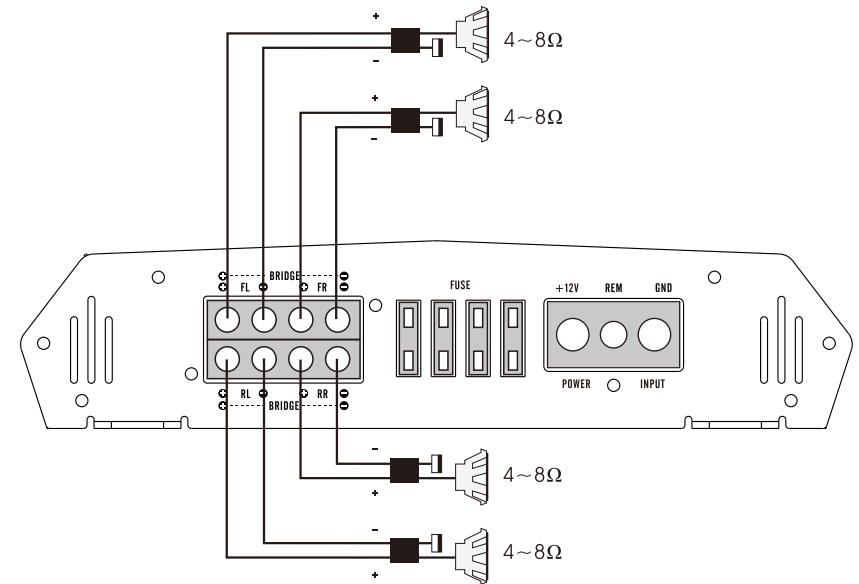
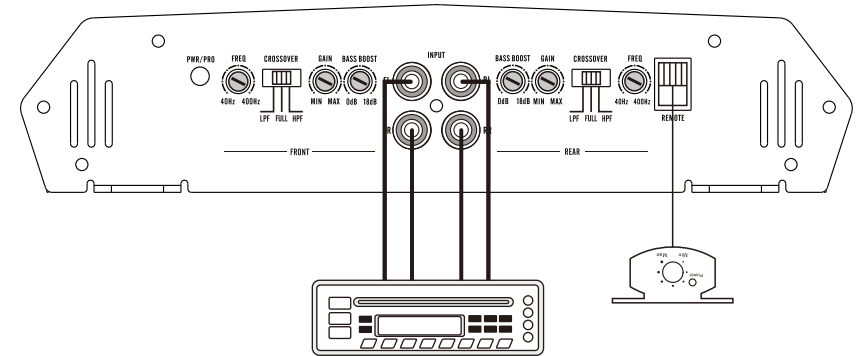

system 2: 3 channel mode

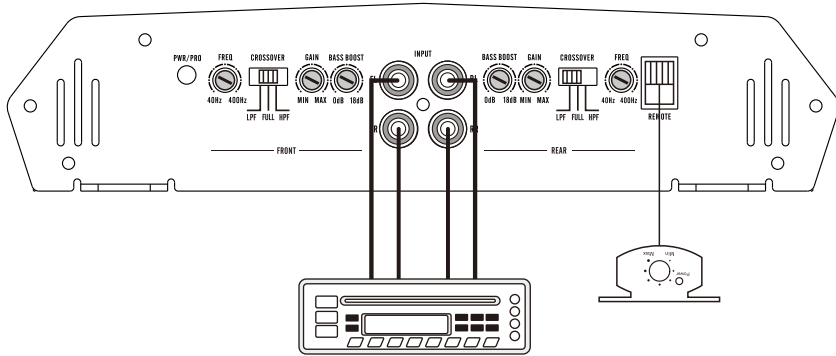

system 3: 2channel bridged connection

